

Est. 1976

Danielle
Fence & Outdoor Living

Call Today
**NEW
LOWER
PRICES!**

2026 Outdoor Living Showcase



50
YEARS
ANNIVERSARY

*Fifty years of commitment
to our customers and community!*

Fence Business Prospers With Family's Helping Hands

The Weather

Partly cloudy skies and warm temperatures through Friday, with a chance of a few showers. High in the low 80's.

The Courier



Index

Church.....	2
Classifieds.....	9
Deaths.....	3
Editorial.....	4
Family Living.....	6
Sports.....	7

VOLUME 96 — NO. 54

ONE SECTION

PLANT CITY, FLORIDA

FRIDAY, MARCH 30, 1979

SINGLE COPY 15¢

By JOY REGISTER

Picking and hauling oranges is not quite like building a fence but survival sometimes will dictate what a person ends up doing.

For the Rileys who own and operate Danielle Fence Company on State Road 60, picking oranges was better than not eating.

"We had to do something," owner Joe Riley said.

And "picking and haulin for 50 cents a box" carried them through.

He had lost his livelihood when the national swimming pool company he worked for folded. The family had been transferred from New Jersey and North Carolina and then left hanging. Picking oranges was a lifesaver. But then Riley said, "I had a friend in St. Petersburg who built fences and I got the idea from him."

TODAY THE FENCE company is going strong — thanks to the entire family.

The family of eight works together and everyone, even down to five-year-old Danielle, whose name was taken for the business, have jobs.

Joe is "boss." At one time he was in the painting and decorating business. Fencing, he said, isn't too far out of line with that.

The reason he feels they are so successful is they can provide a section of fence for \$18.99 and, he said, "That's for first quality."

HE ADDED, "We manufacture the fence and sell it. We don't have high overhead. Others who buy and sell fence have to pay \$18 to \$20 wholesale. So you know who much their fence would have to sell for."

His wife Renee laughed, "Besides we don't have any high salaries."

Son Paul Glogower, 19, who is going to night school and studying architectural drawing at Polk Technical School, goes after the wood.

That has been a major plus for them.

"When we started we were lucky to do 20 sections a week," Riley said. "We couldn't get wood. Now we're doing 100 to 250 sections a week."

THEY CAN DO it now because they have a good supplier.

Mrs. Riley shook her head, "That's one thing we don't tell. Our competition would love to know where we get our wood. But we have a mill that supplies us. We buy all our wood from them and they sell only to us."

The other children have their jobs too, but they like to switch off. They do most of the nailing.

"We don't use any staples," Riley said. "We use galvanized nails that have to be pounded. If someone could invent a nail gun to shoot 4D galvanized nails, we would have it made."

THEY PREFER the galvanized because they don't rust but they do require more work. That's where son Andy Glogower, 18, who is studying at Brown Institute for Broadcasting, Ft. Lauderdale; Marc Glogower, 15, student at Kathleen, and Brandon Glogower, 12, and Kim, 12, both students at Medulla Elementary, come in.

Much of the fence nailing, which includes shadow box, board on board, stockade and dog ear, is done by the boys and Kim often answers the phone. Danielle helps pound a nail now and then and does what she can.

Mama Riley isn't sitting idle while all this is going on. She is busy on Hatcher Road answering the phone, but she is also showing up on door steps to give estimates.

"**I'M KIND OF** a shock to many people. The last thing they expect is for a woman to give estimates, but I do all of it," she said, and remarked that she is never without her calculator.

If someone can't afford the fence, they have another service. They will barter.

"We have gotten a car, stereo, motorcycle, a new motor and mechanical work. Whatever someone has to offer — if we need it we can usually work out a trade. We have all kinds of things from bartering," she said.

Often speaking for the entire group, while her husband and children listen and make a comment now and then, Mrs. Riley proves herself a real go-getter.

"**EDUCATION IS** important to us," she said.

And while the older boys are studying for their fields, Mama is studying too. She "runs the office, keeps the books and is the regular Girl Friday" at home, but she is also majoring in psychology and going to Polk Community College at night. Being a lawyer is her ultimate goal.

Right now she is practicing a certain amount of public relations.

"After every job we send out a letter of appreciation to our customers. We want them to know they are important to us," she said.

They don't have cause to worry at this point. Their aim is to give the public "a decent product at a low price" and their aim is pushing them into overtime.

THEY STARTED out making fences in their backyard. But the zoning department got after them and they moved to their present location on SR 60. They are glad now and hope someday to have their office there.

All their fencing is red cypress, with the exception of some chain link. They carry first quality and seconds and will do the installation, if the customer desires.

They started out four years ago and usually work from 7 a.m. until dark. They all feel the days aren't long enough.

"Everyone is good about working. They all know how important it has been. They are good kids," Mrs. Riley said. And her husband added, "But they have a good argument now and then."

ANDY SAID HIS vacation comes when he goes back to school. But they really don't mind the work and they are proud of their Florida suntans. Other workers are Lamar Alexander, full time, and Allen Dickerson, Marc's friend, part time.

"The family hated the pool business. Now we're working for ourselves and it makes all the difference in the world," Mrs. Riley said.

They started their business — and then prayed, she said.

How could the energetic eight with the "fencing you can trust" be ignored?

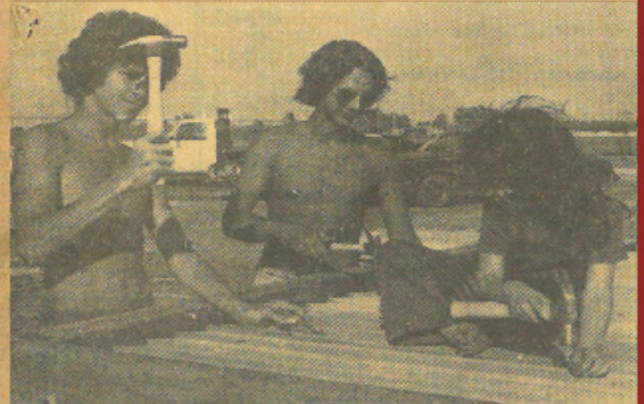

Takes A Lot Of Pounding

Marc and Andy put the fence together with Danielle's help.

Our Work Speaks for Itself!

Vinyl Fence - Privacy, Semi-Privacy, Picket and Post-n-Rail



Aluminum and Wood Fence



Outdoor Kitchens - Dryvit, Stone and Polymer



Outdoor Living - Screen Rooms, Pergolas and Fire Features



Vinyl Privacy Fence



Vinyl Picket Fence



Sacramento Flat Top



Sacramento Point Concave



Sacramento Point Convex



Sacramento Point Straight



Sundance Point Concave



Sundance Flat Top



Sundance Point Straight



Sundance Point Straight

VINYL COLOR OPTIONS

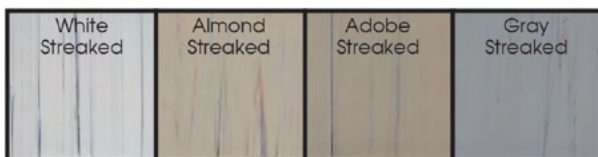
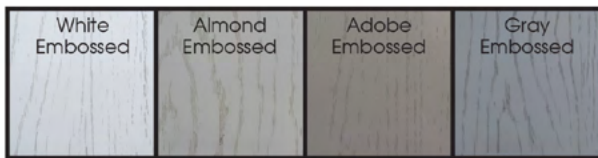
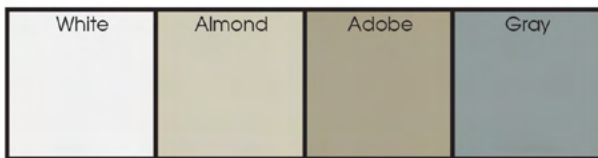

POST CAP OPTIONS

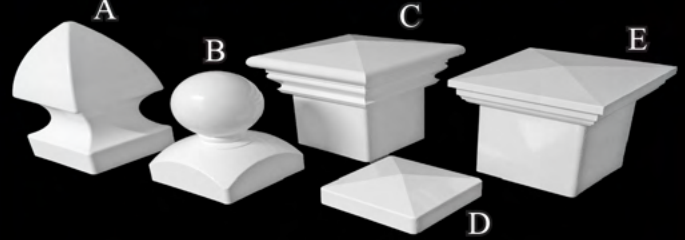

A. Gothic Cap B. Ball Cap (White only) C. Federation Cap D. Traditional Cap E. New England Cap

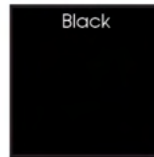

Black

Black PVC Fence Now Available!

See page 33 for pictures of our new Black PVC Fence

Vinyl Post & Rail Fence



2 Rail



3 Rail



4 Rail



NEW

Black Crossbuck

Hurricane Rated .280 Post



Lakeland Industrial Vinyl Fence

Your 5-year shield against high winds

- 5-Year Wind Protection Warranty good from installation date
- Coverage for wind damage up to 75mph and 3 second wind gusts of 100mph (post breaking, rail detachment, structural failure)
- Damage from tornadoes, vehicles, falling trees, vandalism, impact or misuse is excluded
- Gate damage not included
- Must be professionally installed by Danielle Fence, DIY installations excluded
- After our inspection we will determine if a repair or replacement is needed

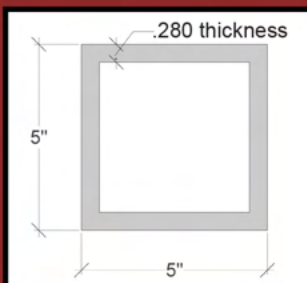

Lakeland Industrial Vinyl Fence

Do It Yourself

We're here for all your DIY needs - we offer parts and kits!

Many extrusion sizes and colors available

Pickets

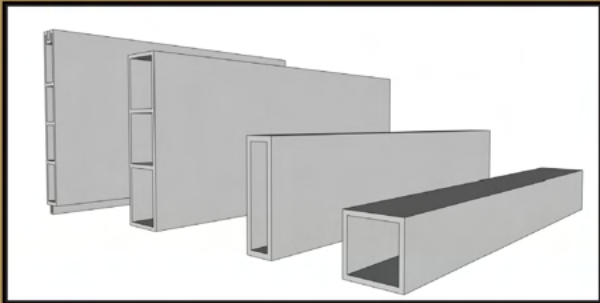

Rails

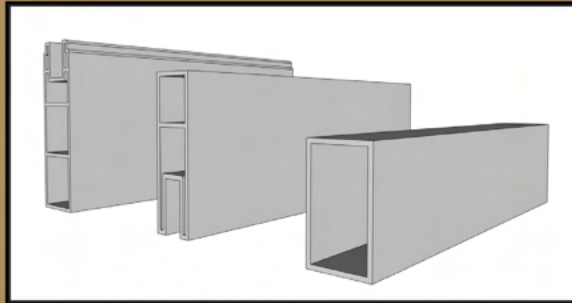

Posts

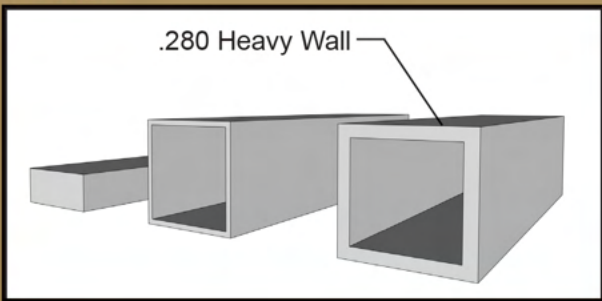

Post Caps & Accessories



Colors:

- White
- Almond
- Adobe
- Gray
- White Embossed or Streaked
- Almond Embossed or Streaked
- Adobe Embossed or Streaked
- Gray Embossed or Streaked
- Black
- Mahogany (see page 34)
- Pine (see page 34)
- Walnut (see page 34)

All Danielle Fence Products are available for any Do It Yourself project

72" x 96" Lakeland



48" x 72" 3-Rail Avalon



48" x 96" Sacramento Flat Top



Available in 1.80", 2.50" or 3.75" spacing

72" x 96" Board on Board



Aluminum Fence

Color may vary from pictures shown.
See sample of actual material prior to purchase.



Black



White



Dark Bronze



Avalon - 2 Rail Flat Top in White



Avalon - 3 Rail Flat Top



Bentley - 2 Rail Pressed Point Straight



Bentley - 3 Rail Pressed Point Straight



Capeview - 3 Rail



Viera - 2 Rail



Viera - 3 Rail



Avalon - Pool Fence

Our Residential Fence is made with 5/8" pickets with 1" x 1" rails and 2" x 2" posts
UPGRADE to 3/4" pickets with 1-1/4" x 1-1/4" rails and 2-1/2" x 2-1/2" posts

Aluminum Fence



Avalon 3-Rail Flat Top Double Picket - Bronze



Avalon Arched Walk Gate



Avalon 4-Rail Flat Top Puppy Picket - Black



Avalon Arched Double Drive Gate - Double Picket

ALUMINUM ADORNMENTS



Standard Post Cap



Ball Post Cap



Pressed Spear



Tri-Ad Finial



Quad Finial



Rings



Butterfly Scroll



Estate Scroll



Decorative Fence

Scrolls are a great way to add
A touch of flair to your new fence.



Chain Link Fence



Vinyl Coated Chain Link



Galvanized Chain Link



Chain Link Gates

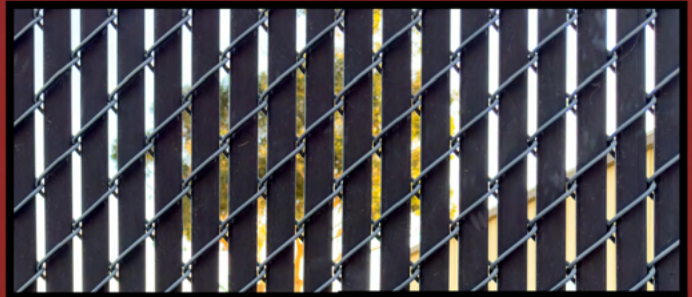

Chain Link Slat Fence



Slat Colors

Wood Post & Rail Fence



5-Rail with alternating rails



4-Rail with wire



Custom 2-Rail



Custom 3-Rail

Wood Fence



Danielle Fence is the originator of the Welded Aluminum Frame Gate.



**4" X 4" Grade Marked
#1 Wood Posts**

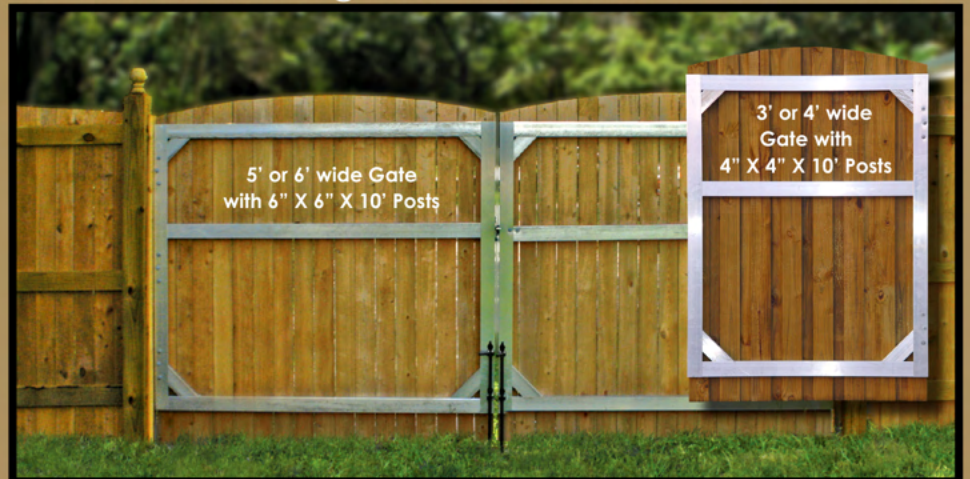

HINGES AND LATCHES Scan QR code to visit our online Hardware Catalog for additional hinges and latches



Butterfly Hinge



Steel Max Latch

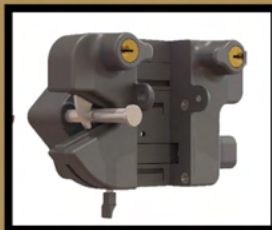

Keystone Traverse Latch



The Chesterfield Textured Vinyl Fence

Woodgrain texture and “multi-chromatic” color blends recreate the natural beauty of stained wood in an easy-to-maintain vinyl fence.



Chesterfield Arctic Blend w/Swoop Accent



Clay CertaGrain Texture



Chesterfield Brazilian Blend w/Concave Accent



Honey Blend CertaGrain Texture



Chesterfield Sierra Blend w/Lattice Accent

Post & Rail CertaGrain

- Authentic woodgrain texture
- Safe and durable horse enclosure
- Economical and virtually maintenance free



Sierra Blend 4-Rail



Brazilian Blend 3-Rail



Arctic Blend 2-Rail

Simulated Stone Fence

Decorative stone-look fence system featuring a distinctive granite stone look.



Simulated Wood Fence

Features rich colors and dramatic texture, which gives our panels a realistic wood appearance.



Colors may vary from pictures shown. See sample of actual material prior to purchase

Est. 1976

Danielle

Fence & Outdoor Living

Trusted, Reliable and Ready



Since 1976
Danielle
Fence Mfg. Co.
(863) 646-6794
www.DanielleFence.com



Outdoor Kitchens



Fire Features



Arbors • Gazebos • Pergolas



Through the Years

Some Early Work



Danielle Fence goes Vinyl

Since 1988 Danielle Fence has been at the forefront of the PVC Fence Industry, creating many styles and designs that are fabricated in our Mulberry Florida facility. These fence styles are now sold around the world. Some examples of these are our Lakeland, Hollingsworth, Lakeview and Sacramento. Often copied but never duplicated with the same quality and expertise.



Through the Years

New Venture into Outdoor Living

In 2012 Danielle Fence expanded into the Outdoor Living world; specializing in Outdoor Kitchens, Screen Rooms and Pergolas. This new venture found Danielle Fence being involved with some of the country's greatest Gardens and Parks. With Bok Tower Gardens, a 250 acre garden and bird sanctuary in Lake Wales Florida, Danielle Fence designed and constructed a 6,400 square foot Outdoor Kitchen complete with a wood-fired pizza oven and top-of-the-line appliances. A few years later Danielle Fence was honored to find itself as a part of Bonnet Springs Park, an award winning new urban/nature park in Lakeland Florida. Some of the features contributed to Bonnet consisted of a Pergola to the Rooftop Bar, an Outdoor Kitchen to the Event Center, Copper Screen Enclosure for the Boathouse and Butterfly Garden.

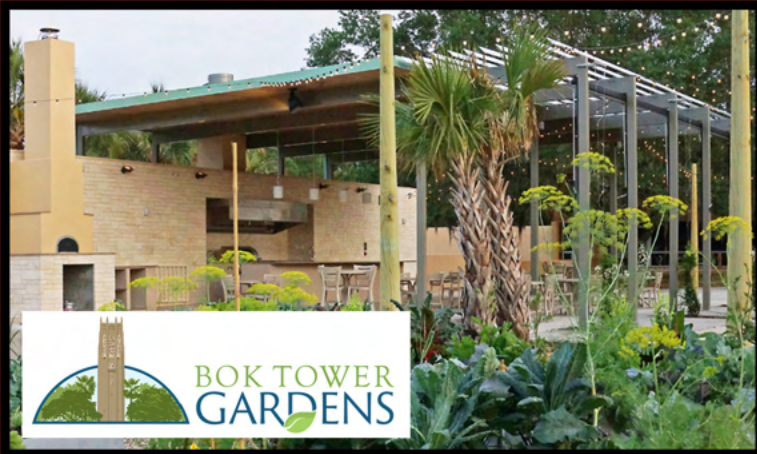

Innovations

Designed and manufactured vinyl litter cans, used in some of Florida's luxurious resorts.



From concept . . . to reality!



**Have an empty space on your patio?
Add an Outdoor Kitchen by
Danielle Fence & Outdoor Living!**

**Our Designers are
ready to assist
you with your new
backyard!**

**Ask TODAY about your
3-D Backyard Design!**



At Danielle Fence & Outdoor Living we provide beautiful outdoor living spaces, both large and small. Whether your perfect outdoor space will be for an evening by the fire pit or hosting the annual block party BBQ, our Design Team will take the time to help you design the perfect outdoor living space for your home.



Before



3-D Concept



Completed

3-D Designs We Do That!

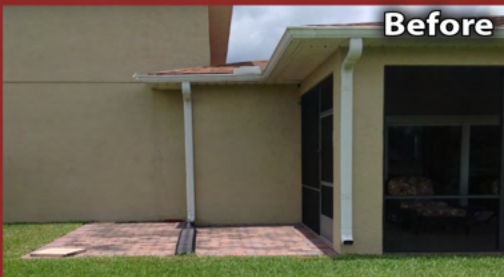

Screen Rooms



Screen Room w Insulated Roof



Screen Enclosures



Screen Room w Insulated Roof



Pool Enclosure



Screen Rooms

Fireplaces - Fire Features



Firefalls



Fire Tables



Electric Fireplaces



Fire Bowls



Fire Burners

Outdoor Kitchens

GRANITE OPTIONS



Santa Cecilia



Santa Cecilia Gold

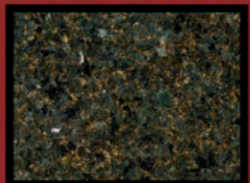

Uba Tuba

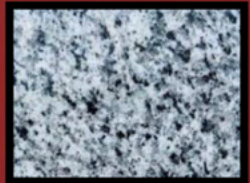

Vale Nevada



Dryvit



Dryvit



Grill Hoods



Dryvit - Radius



Use the QR code for more information on all of our Outdoor Kitchens

Outdoor Kitchens

Polymer Color Options

Black	Charcoal Gray	Basil	Dolphin Gray	White	Mocha	Nutmeg	Sandshade	Seafoam	Indigo
-------	---------------	-------	--------------	-------	-------	--------	-----------	---------	--------



Polymer



Polymer



Stacked Stone



Stacked Stone

Summerset Grills



Sizzler 32" Built-In Grill



Sizzler Pro 32" Built-In Grill



TRL Pro 32" Built-In Grill



Doors & Drawers



Double Doors



Vertical Door



Two Drawer



20" Trash Drawer

Side & Power Burners



Sizzler Double Side Burner



Sizzler Pro Power Burner



American Made Grills

Hybrid Grills - revolutionary grill series that allows you to cook with gas, wood, charcoal, lump coal and more



American Muscle Grill



Encore Grill

Both grills available in 36" and 54" models



Available in Cart Models



Gas Grills - classic, high performance grill series



Estate Grill

Available in 30", 36" and 42"



36" Atlas Grill



Side & Power Burners



Muscle Power Burner



Muscle Double Sideburner



Encore Double Sideburner

Fire Magic Grills



Doors & Drawers



Aurora 660i Built-In Grill



Deluxe Gourmet Drop-In Grill



Double Doors



Vertical Door



Triple Drawer



Trash Drawer



Warming Drawer

Aurora Pizza Oven



Side & Power Burners



**Echelon
Double Side Burner**



**Aurora
Double Side Burner**



**Aurora
Power Burner**

Electric Grills



SAVOR THE MOMENT™



Electric Built-In Grill



Electric Tabletop Grill

American Muscle Grill



EVO the natural way to cook



Built-In Grill



Cart Model



Table Top Model



Many Different ways to use your EVO grill!

- Boil • Braise • Fry • Grill
- Poach • Saute
- Sear • Steam • Stir-Fry • Toast

Summerset Griddle Grill



Available in both LP and NG options

Summerset New Products

Summerset Hybrid Pizza Oven



Whether you want the rich, smokey essence of wood-fired cooking or the exacting control and efficiency of gas, this oven brings both to the table with precision and most importantly, flavor.

Summerset Outdoor Refrigerator



Enjoy the convenience of outdoor refrigeration without taking up too much space when you have the Summerset 22-inch Outdoor Refrigerator. This refrigerator is compact yet internally spacious, giving you ample room for storage. With the interior LED lighting, you can easily see inside to find the drink or ingredients you are looking for.

Summerset Griddle Grill

Create without limits, from sunrise breakfasts to late-night street-style tacos. The commercial-grade Gas Griddle Pro delivers even heat and precise control, turning your outdoor space into a hub for bold flavors and inspired cooking. Whether searing, sizzling, or flipping, every meal becomes an experience worth savoring. Available in both built-in and cart model.



Available in both LP and NG options

Pergolas



Aluminum Pergola



Vinyl Pergola



Aluminum Pergola



Vinyl Pergola



Vinyl Pergola



Scan here to see some of our other Pergolas online!

Barricades and Litter Cans

Vinyl Barricades



Vinyl Litter Cans



NEW Black PVC Fence



New Fence Products

Timber Estate Fence



Check out our new video Spotlight on this fence!



Trex Fence



Danielle Series Composite Fence

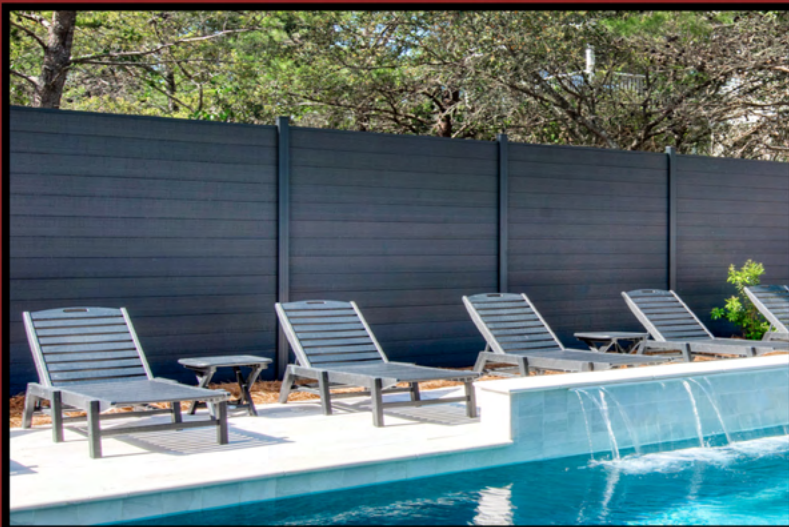

At Danielle Fence & Outdoor Living, we pride ourselves on being a company you can trust in providing high-quality installations, materials, customer service & estimates. Servicing residents of Polk, Hillsborough, Pasco, Pinellas, Manatee and South Florida Counties.

Danielle Fence has installed over 5.5 million feet of fence serving over 250,000 families since 1976!



www.DanielleFence.com

Check out our weekly installs on



Danielle Fence & Outdoor Living has been here to serve you from...



1976



1995



Today



Visit our Design Center Today or call for a FREE Estimate!

DANIELLE FENCE OBTAINS IT'S MANUFACTURING LICENSE

in the world



U.S. President
Gerald Ford (38th)

U.S. Population
218 million



World Population
4.14 billion

on the big screen

- Rocky
- A Star is Born
- King Kong
- Bad News Bears
- Call of the Wild
- Outlaw Josey Wales
- The Omen



oscar winners

- Best Actor:**
Jack Nicholson
(One Flew Over the Cuckoo's Nest)
- Best Actress:**
Louise Fletcher
(One Flew Over the Cuckoo's Nest)
- Best Director:**
Milos Forman
(One Flew Over the Cuckoo's Nest)
- Best Picture:**
One Flew Over the Cuckoo's Nest



year in review

January 1 - The nation celebrates it's bicentennial year, marking 200 years since the Declaration of Independence.

April 1 - Apple Computers is founded by Steve Jobs, Steve Wozniak and Ronald Wayne.

July 20 - NASA's Viking 1 landed successfully on Mars, becoming first spacecraft to achieve a long-term successful landing.

February 1 - Danielle Fence obtains it's manufacturing license. At the time the jobs solely consisted of wood fence, but soon after it's initial startup the first vinyl fence in Florida was introduced in 1988. Now 50 years later a life's journey has grown from one family to well over 100.

on the radio

- Silly Love Songs (Wings)
- Oh What a Night (Four Seasons)
- Play that Funky Music (Wild Cherry)
- Bohemian Rhapsody (Queen)
- Boys Are Back (Thin Lizzy)
- Dream On (Aerosmith)
- Slow Ride (Foghat)
- Breezin' (George Benson)



what things cost

New House	\$48,000
New Car	\$5,450
Gallon of Gas	\$0.60
Loaf of Bread	\$0.60
Dozen Eggs	\$0.80
Gallon of Milk	\$1.50
First-class Stamp	\$0.13
Movie Ticket	\$2.13



Average Income Per Year
\$12,690.00

sports champions



NFL Champions

Pittsburgh Steelers

MLB Champions

Cincinnati Reds

NBA Champions

Boston Celtics

NHL Champions

Montreal Canadiens

born in 1976

- | | |
|--------------------|----------------|
| Danielle Fence | Colin Farrell |
| Ryan Reynolds | Tom Hardy |
| Alicia Silverstone | Chris Pratt |
| Blake Shelton | Channing Tatum |
| Luke Bryan | Peyton Manning |